

1064nm 4-port High Power Optical Circulator

FEATURES

- High Isolation
- Low Insertion Loss
- Epoxy-Free Optical Path
- High Reliability and Stability
- Low Profile Packaging

APPLICATIONS

- Fiber Optic Amplifiers
- Fiber Optic Instruments
- WDM Systems
- Dispersion Compensation
- Light Routing

SPECIFICATIONS

Parameter	Unit	Value
Center Wavelength	nm	1064
Operating Wavelength Range	nm	+/- 10
Insertion Loss@ 23 °C (1→2, 2→3, 3→4)	(Typ.) dB	1.0
	(Max.) dB	1.8
Isolation @ 23 °C (4→3, 3→2, 2→1)	(Typ.) dB	25
	(Min.) dB	22
Optical Return Loss	dB	≥45
Polarization Dependent Loss	dB	≤0.2
Fiber Type	-	HI1060 Fiber or 10/125um SC Fiber (E) 10/125um DC Fiber (O), 15/130um DC Fiber (W) 20/130um DC Fiber (Q) or 25/250um DC Fiber (R)
Fiber Tensile Load	N	5
Maximum Optical Power	W	0.5, 1, 2, 3, 5, 10, 15, 20, 25, 30
Operating Temperature	°C	0~50
Storage Temperature	°C	-10~65

- Note:**
1. Specifications are for device without connectors; Specifications may change without notice.
 2. To add connectors, IL is 0.5dB higher, RL is 5dB lower.
 3. Only guarantee 1W continuous wave (CW) power thru testing for connectors added.
 4. Devices for higher optical power or with other type fiber or consigned fiber are also available; Devices can only work in the core of Double Cladding (DC) Fiber, Cladding Power must be stripped before connecting the device

PACKAGE DIMENSION

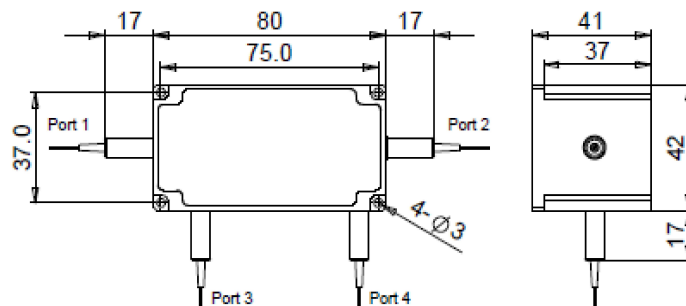

ORDERING INFORMATION (PN)

FCIR-	NNNN	-4HP NN	- (C)	C	NN	- CC/CCC
<i>Center Wavelength</i>	<i>Optical Power</i>	<i>Fiber Type</i>	<i>Fiber Sleeve</i>	<i>Fiber Length</i>	<i>Connector Type</i>	
1064=1064nm	05=500mW 1=1W 5=5W 20=20W	E=10/125 SC Fiber Q=20/130 DC Fiber R=25/250 DC Fiber Blank for HI1060 Fiber	B= Bare fiber L= Loose Tube 2= 2mm Cable 3= 3mm Cable	05=0.5m 10=1.0m 15=1.5m 20=2.0m	N=Without Connector FC/APC=FC/APC Connector LC/PC=LC/PC Connector SC/UPC=SC/UPC Connector	